

# Analogue Signal Transmitter AST 3

From prog.name A001A140

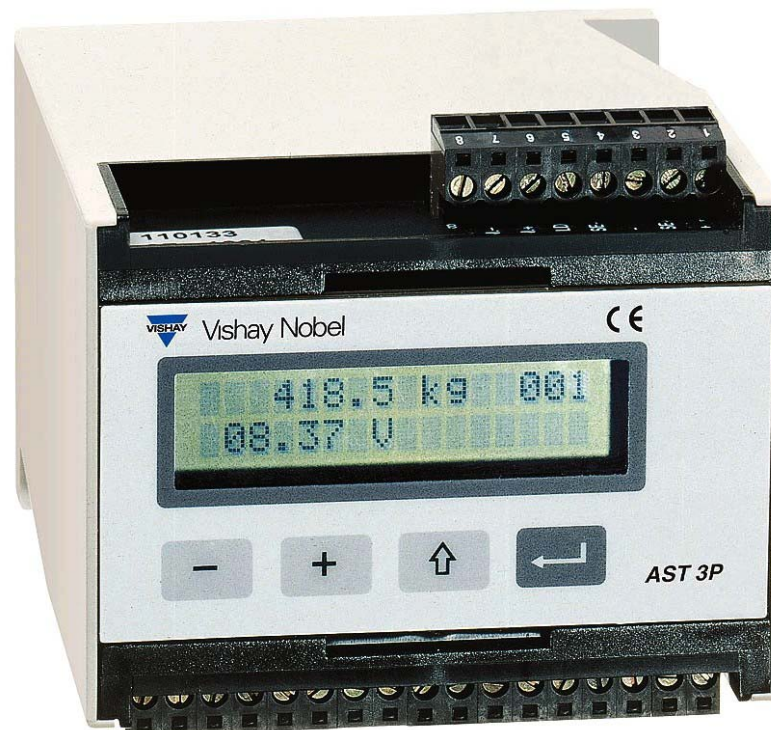

Operating instructions,  
Quick installation



# Contents

## Introduction

.....	1
-------	---

## Operating instruction

General .....	2
Power supply .....	2
Start-up .....	2
View alternatives .....	3
Zero setting .....	4

## Installation

Mechanical installation .....	5
Electrical installation .....	5
Set-up programme deltaCOM .....	6

## Quick set-up, calibration

General .....	7
Common parameters .....	7
Data sheet calibration .....	11
Dead weight calibration .....	14

## Parameter survey

.....	18
-------	----

## Quick set-up list

.....	App. 1
-------	--------



# Introduction

AST 3 is a high performance transmitter, designed for industrial measuring by means of strain gauge transducers. The compact module is easily installed on a DIN rail or a flat surface.

Two slightly different versions of the transmitter module are available:

AST 3B, designed for operation together with a control unit.

Instructions for installation and set-up are found on a diskette, delivered with the transmitter module.

AST 3P, with display window and function keys for set-up and measuring operations.

This instruction includes the basic installation and set-up, required for correct measuring with the instrument.

Additional installation and set-up of more instrument functions, not covered by this description, can also be performed.

For a complete instrument description, refer to publication 600 232:

AST 3 Technical Manual

## This description deals with the following points:

- Using the AST 3P panel for measuring.
- Quick installation.
- 'Quick set-up' for AST 3P.
- Data sheet calibration.
- Deadweight calibration in two points.
- Installation of deltaCOM.

## This description does NOT deal with the following points:

- Connection of relay output.
- Complete set-up (password, filters etc.).
- Adjustment of levels and relay functions.
- Adjustment of the analogue output.
- Setting of communication parameters.
- Table calibration.
- Troubleshooting.
- Diagnostics.

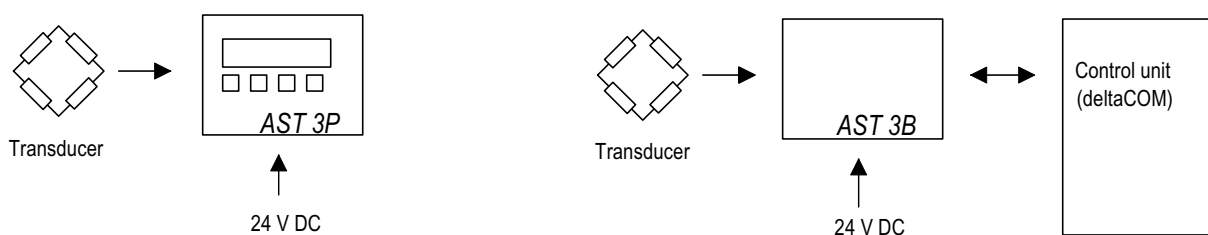

Figure 1. Different versions need different installation for parameter set-up.

# Operating instructions

## General

This section describes display and function key operation for AST 3P in normal Operating mode.

## Power supply

Power supply to the signal transmitter should not be turned off during week-ends and over-night. Continuous power supply to electronics and transducers prevents moisture condensation in the units.

## Start-up

As soon as power is connected to the instrument, start-up is performed. The text 'AST 3', the programme name and the serial number of the module are displayed for about five seconds.

Then AST 3P is automatically switched over in Operation mode.

(If the instrument is set for operator start-up, the text 'Press ENTER to start AST' is displayed until the key to the right is pressed and the instrument enters Operating mode.)

If an error occurs the start-up stops and an error message is displayed. Error codes and error corrections are described in section 7. Troubleshooting in the Technical Manual for AST 3.

As AST 3 is in Operating mode, a view with the weight value and the instrument address is displayed.

For the internal relays in use, the status is displayed (R1/R2: On or Off).

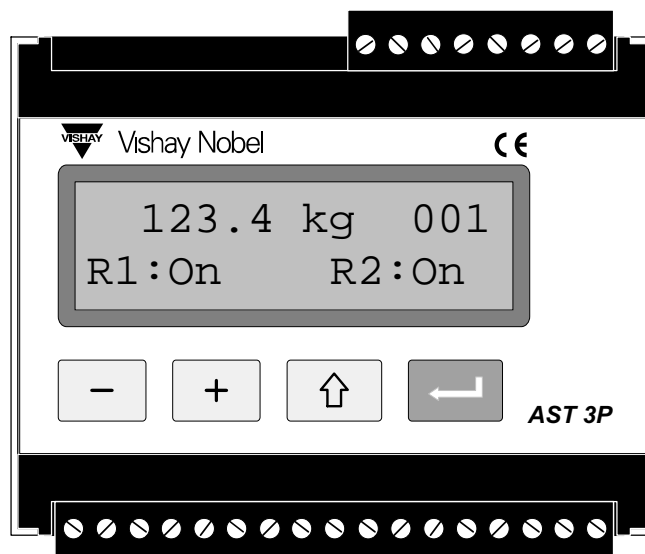

Figure 2. Front view of AST 3P in Operating mode. A weight value and information about address and relay status being displayed.

## View alternatives

AST 3P set-up may allow display of more views than Weight value. In that case the function keys  and  are used, according to figure 3, to select a view.

### Weight value, normal view.

This view displays the actual measurement value, here called weight value, and the instrument address. For the relays in use the status, On or Off, is displayed.

### Zero setting.

This view displays the weight value and the address, and on the second line the text 'Zero' above the key .

Zeroing of the weight value is performed as  is pressed.

The zeroing performed in this view is only temporary. After power-off or reset it will be replaced by the zero setting from the latest calibration.

### Analogue output.

This view displays the weight value and the address, and also the actual analogue output signal.

### Level settings.

This view displays the switching levels for the two supervising channels. If these channels are not in use, level 0 is displayed.

### Input signal.

This view displays the actual input signal from the connected transducer(s). The instrument address and status for the used relays are also displayed.

### S/N:, Progr.

This view displays the instrument serial number and the name of the installed programme.

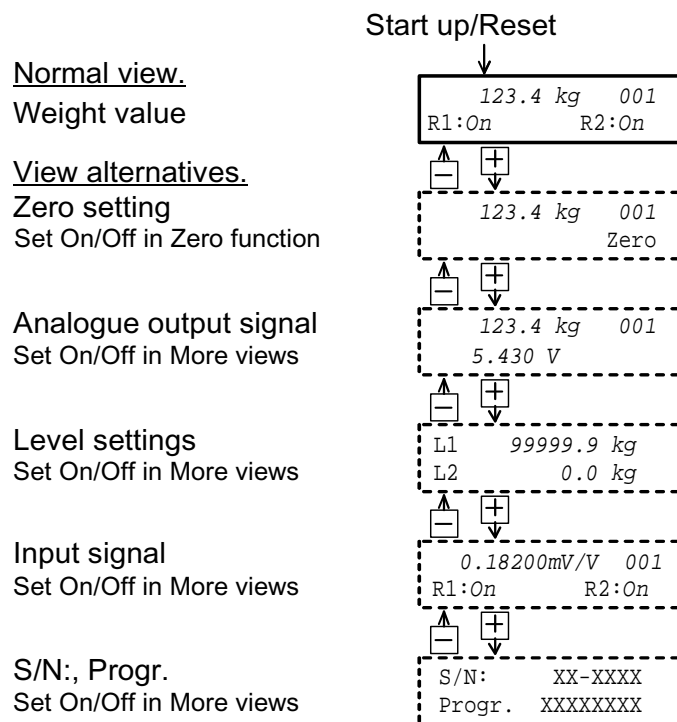

Figure 3. AST 3 in Operating mode can always display the weight value. Depending on the setting, display of alternative views can be selected by keys + and -.













## Zero setting

Zero setting in normal operation can be performed if the 'Zero setting' view is enabled, see previous page, but that zero setting is only temporary.

To perform a zero setting, saved in the instrument memory, the normal operation must be interrupted and the following sequence in set-up mode carried out.

This type of zero setting is included in the calibration sequences, but a separate zero setting may also be needed, for example if the equipment on the scale has been changed, influencing the weight.

### Procedure

1. Check that the scale is unloaded before performing the zero setting.
2. Switch to set-up mode by holding ESCAPE (  ) pressed for 2 seconds.
3. Enter the valid password, if this is demanded.
4. The text 'Main menu Quick set-up' is displayed.  
Press ENTER (  ).
5. The first parameter name, 'Language', is displayed.  
Press  a number of times until 'Set zero' is displayed. The parameter value for 'Set zero' is a live weight value.
6. Press  . The parameter value is set to zero and a blinking cursor appears to the left on the second line.  
(The zero setting can be cancelled by pressing  )
7. Press and hold  for 2 seconds to confirm the new setting.  
The cursor disappears and a live weight value is displayed.
8. Press  , read and make a note of the 'Zero offset' value in Appendix 1.  
(The 'Zero offset' value can be used for set-up of a replacement instrument.)
9. Press  .  
The display changes to 'Main menu Exit set-up.'
10. Press  .  
The display changes to 'Save changes? No Esc. Yes'.  
(Press  (Esc.) if you do not wish to exit from the set-up mode.)
11. Press  (No) to cancel the change and return to the previous zero setting,  
or  
Press  (Yes) to save the new zero setting in the instrument.
12. AST 3P restarts with the selected zero setting.



# Installation

## Mechanical installation

Each signal transmitter module AST 3 contains several circuit boards, built into a protective plastic housing. The module can be snap-mounted on a 35 mm wide DIN rail, or mounted on a flat surface by two 4 mm screws. Mounted modules should have at least 10 mm free space on each side.

## Electrical installation

For the electrical connections to the terminal blocks, shielded cables are needed except for the power supply. All cables should be routed so that electromagnetic interference from power cables is avoided.

Cable connection is shown in the diagrams below.

### Transducer input

Terminals 1 – 7 (8).

Transducer connection should be handled with great care to achieve good measuring data. Integrated transducer cables may not be shortened.

**NOTE!** Transducer cables must be routed at least 200 mm away from 230/380 V, 50/60 Hz power cables. By cables with other frequencies or high power, an even wider distance is preferable.

4-wire connection should be used if the integrated transducer cable can be connected directly at AST 3. By 4-wire connection, excitation and sense must be interconnected at AST 3, see diagram below. The cable shield and terminal 5 should be connected to earth via the mounting rail.

6-wire connection should be used if the integrated cable must be lengthened or if several transducers should be connected to one AST 3 unit.

Connect the cable shield and terminal 5 to earth via the mounting rail. In the diagram below connections are shown for the junction box SL-4 from Vishay Nobel.

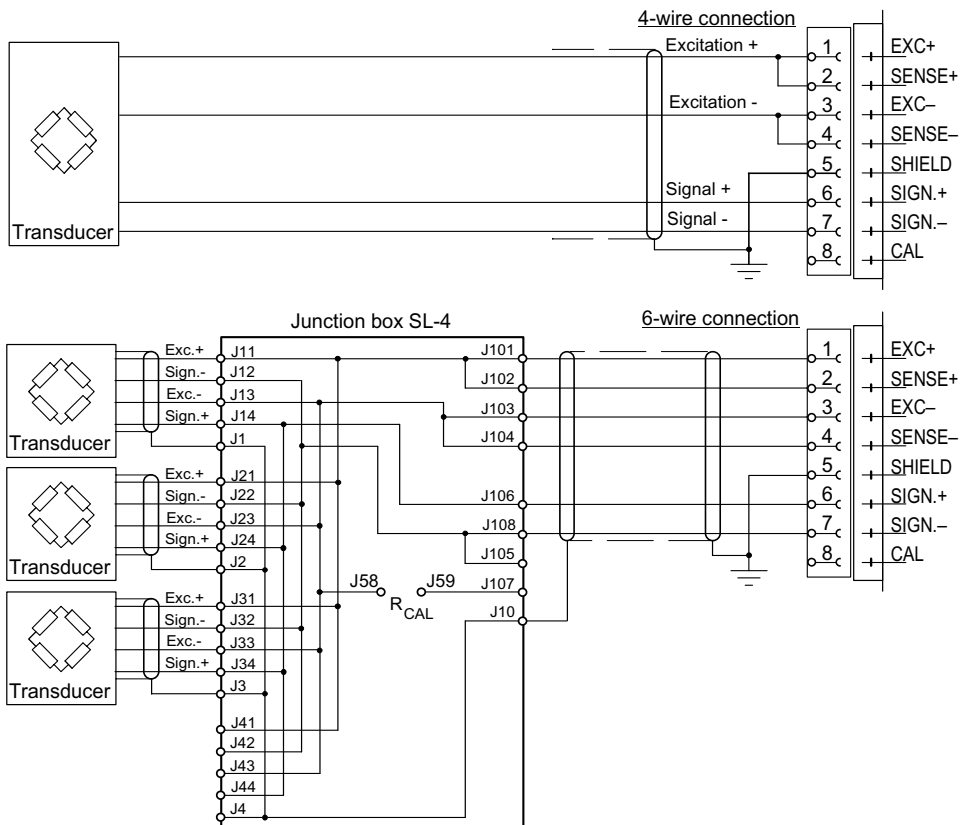

## Power supply

Terminals 17, 18.

The AST 3 module is powered by 24 V DC.

Rail mounted power supplies can be ordered from Vishay Nobel.

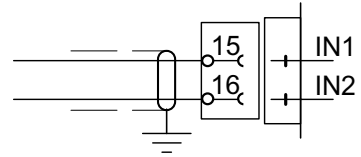

## Analogue output

Terminals 24, 25.

The measurement value is presented as a current or voltage signal, according to set-up selection.

Connect the cable shield to ground, preferably to a ground terminal at the mounting rail.

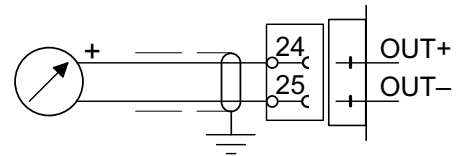

## Serial communication

Terminals 19 – 23.

Set-up by serial communication is needed to take AST 3B into operation. All AST 3 have a serial port for RS-485 on 2-wires or 4-wires with common earth (COM). If necessary, a converter unit should be connected to adapt the interfaces.

The line must have 120 ohm termination at both ends. For AST 3 it should be mounted on separate terminals and connected according to the diagrams. Refer to manufacturer instructions for termination at the control unit (PC), or at the converter unit.

Connect the cable shield to ground, preferably to a ground terminal at the mounting rail.

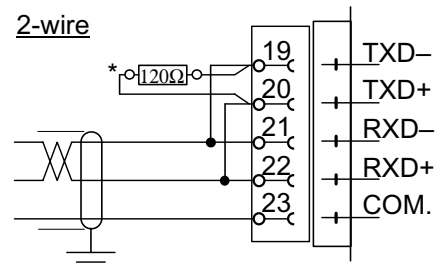

\* Terminating resistor on separate terminals at the last unit on the line.

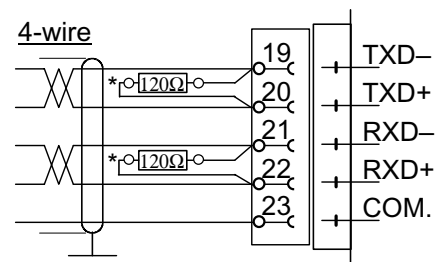

\* Terminating resistor on separate terminals at the last unit on the line.

## Set-up programme deltaCOM

AST 3B must be connected to transducer(s) and power supply, and also to a PC with Windows 95/98/2000/XP/NT4.0 to make set-up possible. Included in the AST 3 delivery is a diskette with the set-up programme deltaCOM. This diskette also contains instructions for connection and set-up of the serial communication between the instrument and the PC.

To install the programme, insert the diskette in the computer, press the 'Start' button and select 'Run...' from the menu, type [drive letter]:\setup in the dialogue box and then follow instructions on the screen.

If nothing else is stated, the programme deltaCOM and a ReadMe file will be found in Start > Program > deltaCOM.

By use of deltaCOM it is possible to find all AST 3 modules communicating with the PC, and to study and edit all set-up parameters for these modules.

# Quick set-up, calibration

## General

Set-up of all parameters in AST 3 can be performed from the programme deltaCOM by serial communication. For AST 3P set-up can also be performed from the panel of the module, for example the 'Quick set-up' of certain parameters described in this section. To make a similar set-up for AST 3B, the 'Quick set-up' parameters can be selected from the tabs 'General', Analogue output' and 'Calibration' in deltaCOM.

Calibration is essential for the instrument to give correct measurement results.

Two calibration methods are available in the 'Quick set-up':

Data sheet calibration, for calibration when load cell data is available and the installation is free from disturbing mechanical forces.

Dead weight calibration, normally the most accurate calibration method, where known weights are used to give well defined loads on the scale.

Before selection of calibration method, the value of some common instrument parameters must be set.

All parameter values from the calibration should be noted in the set-up list, see Appendix 1. These values are useful later, if the instrument must be replaced.

## Common parameters

These parameters are defining: the language, measurement unit and resolution for the instrument and also the capacity and signal type for the analogue output.

## Set-up

### 1. Access 'Quick set-up'

At normal operation AST 3P displays the actual measurement value and the module address. Status for the internal relays (R1/R2) in use is also displayed.

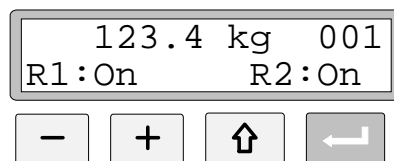

Press and hold the ESCAPE key for 2 seconds.

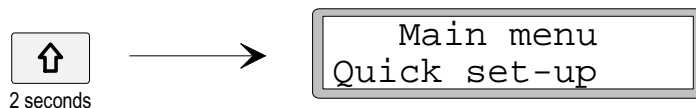

This switches the instrument into Set-up mode, displaying the main menu for 'Quick set-up'.

As AST 3 is in Set-up mode, normal measuring functions are interrupted!

## 2. Showing the parameters.

Press ENTER.



The first parameter in 'Quick set-up' will be displayed.

## 3. Edit the language (a choice parameter).

'Language' is a choice parameter with a number of alternatives available.

Press ENTER to make editing possible.

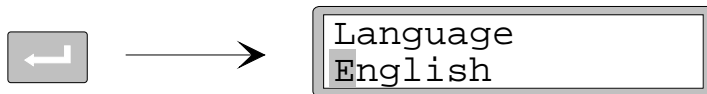

A cursor starts blinking to the left on the parameter value line.

Press **+** to step forwards to next alternative, or press **-** to step backwards to the previous alternative, until the correct alternative is displayed.



Press ENTER for 2 seconds to accept the displayed alternative.

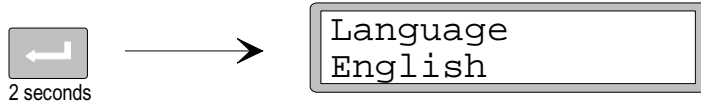

The cursor disappears and the displayed alternative is activated.

## 4. Edit the measurement unit for the instrument.

By this parameter, the unit of the measurement value is defined.

Press **+** to get parameter 'Measurement unit' displayed.



Press  if the measurement unit should be edited, and edit the value like in point 3. above.

### 5. Edit the instrument resolution.

With this parameter, the number of decimals and the resolution of the last digit of the measurement value are defined.  
This parameter influences all measurement values using the measurement unit.

Press **+** to get parameter 'Resolution' displayed.

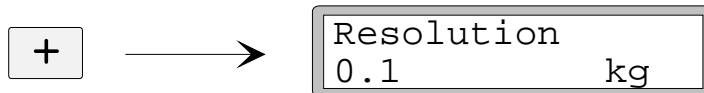

Press **↵** if the resolution should be edited, and make the editing like in point 3. on page 8.

In the following examples, resolution with two decimals is used.

### 6. Edit the instrument capacity (numeric parameter).

This parameter defines the capacity of the instrument, i.e. the weight value that corresponds to full range at the analogue output.

Press **+** to get the parameter 'Capacity' displayed.



Press ENTER to make editing possible.



A cursor starts blinking to the left on the parameter value line, indicating which sign or digit that can be edited.

Press ENTER to move the cursor, step by step to the right in the parameter value, to the digit to edit.



Press **+** (or **-**) until the wanted digit value is displayed (1 in this example).



When necessary, press ENTER again to move the cursor to another digit to edit.

Press ENTER for 2 seconds when the capacity parameter value is correct.

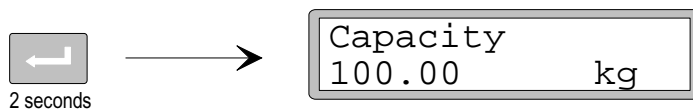



The cursor disappears, and the edited parameter value becomes active.

## 7. Edit the analogue output type.

The signal type for the analogue output is defined by parameter 'Ana. output type' that has a number of alternatives.

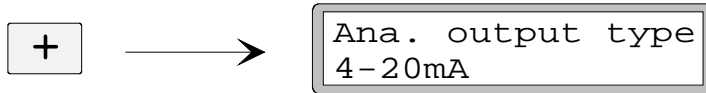
Press **+** to get parameter 'Ana. output type' displayed.



Press  if the parameter should be edited, and make the editing like in point **3.** on page 8.

## 8. Chose a calibration type.

Two calibration types can be chosen in 'Quick set-up': Data sheet and Deadweight. As a new calibration shall be performed, AST 3P must first be set for editing, indicated by a cursor at the parameter value. Then one of the alternatives must be chosen and accepted.

Press **+** to get the parameter 'Calibration type' displayed.

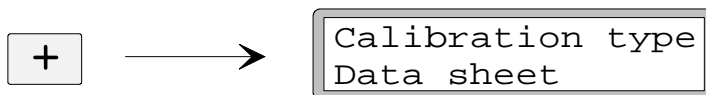

The value points out which type of calibration that was performed last time.

If a new calibration shall be performed, press ENTER to set the instrument for editing.

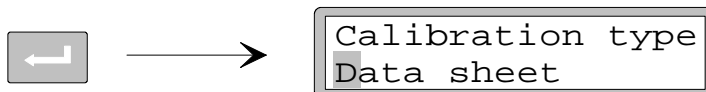

A cursor starts blinking to the left on the parameter value line.

Chose an alternative for the parameter like in point **3.** on page 8.

When  is pressed for 2 seconds, the chosen calibration type gets active and the calibration can start.

The choice of calibration type determines which parameters will follow:

For Data sheet, se point **9.** on page 11.

For Deadweight, se point **9.** on page 14.

## Data sheet calibration

This calibration type can be used when transducer data is available, the load is evenly distributed on the support points and the weighing installation is not influenced by disturbing external forces.

Before editing of the following parameters is started, set-up of common parameters, described in point 1. – 8. on pages 7 – 10 should be performed.

### 9. Edit the conversion factor.

If the 'Data sheet' alternative was selected at 8. on page 10, next parameter will be 'Conv. factor'. This parameter defines a constant by which a weight value, expressed in the measurement unit, should be multiplied to be expressed in the data sheet unit.

Default value for the parameter, 9.80665, can be used when the data sheet unit is Newton (N) and the measurement unit is 'kg'.

If data sheet unit and measurement unit are equal, the value should be 1.00000.

Press **+** to get the parameter 'Conv. factor' displayed.

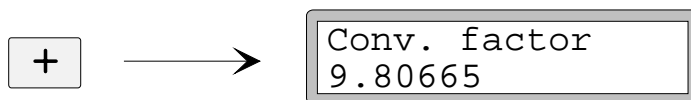

Press ENTER to make editing possible.

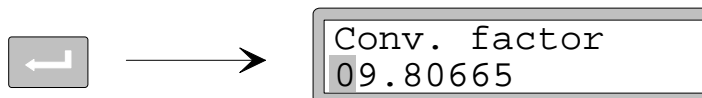

A cursor starts blinking to the left on the parameter value line.

Now editing can be performed for each digit individually.

See point 6. on page 9 (numeric parameter).

Press ENTER for 2 seconds when the conversion factor is set to a correct value.

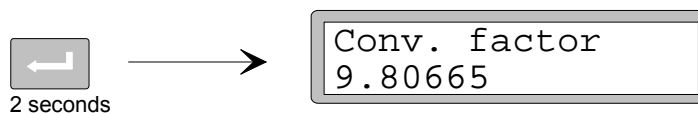

Cursor and leading zeros disappear, and the edited conversion factor will be active.

### 10. Edit the number of transducers.

This parameter defines the total number of support points for the load, including transducers and fixed supports.

Press **+** to get the parameter 'Number of transd' displayed.

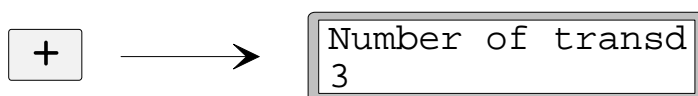

Press **←** if the parameter value should be edited, and make the editing like in point 6. on page 9 (numeric parameter).

### 11. Set the rated load for one transducer.

It is assumed that all transducers connected to the instrument have the same rated load and impedance. The rated load for one transducer, expressed in the data sheet unit used to calculate the conversion factor (see 9. on page 11), should be entered.

NOTE! If the data sheet value is for instance 5 kN, this parameter should be set to 5 000 (N).

Press **+** to get the parameter 'Rated load' displayed.



Press  if the parameter value should be edited, and make the editing like in point 6. on page 9 (numeric parameter).

### 12. Set the rated output for the transducers.

Rated output for each transducer, a value in mV/V, is given in the data sheet. For fixed support points the rated output should be set to "0.00000".

Press **+** to get the parameter 'Rated output 1' displayed.



Press  if the parameter value should be edited, and make the editing like in point 6. on page 9 (numeric parameter).

Parameters will follow for the number of support points given at 10. on page 11. Set the parameter value to the rated output for each transducer/fixed support.

### 13. Set the scale to zero.

This parameter displays the weight value with actual settings (but with one decimal more than what is set in 'Resolution'). Use it to set the weight value to 'zero' for the unloaded scale.

Press **+** to get parameter 'Set zero' displayed, and check that the scale is unloaded.



Press ENTER to set the parameter value to zero.

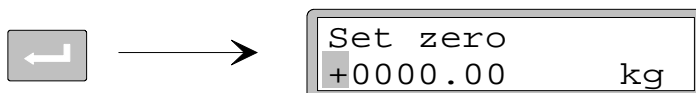

The value is set to zero with leading sign and a cursor blinking.

Press ENTER for 2 seconds.

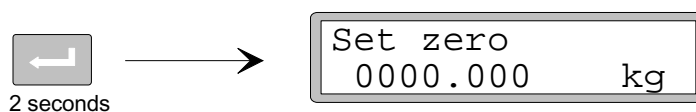

The cursor disappears and the zero setting is accepted.



#### 14. Read the zero offset.

By installation later of a replacement instrument, it is useful to know the total zero offset value for the scale.

Press **+** to get parameter 'Zero offset' displayed.

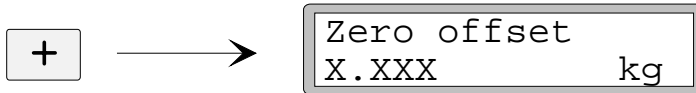

Make a note of the zero offset value in the Quick set-up list, appendix 1.

#### 15. Exit 'Quick set-up'.

Press ESCAPE to get to 'Main menu Exit set-up'.

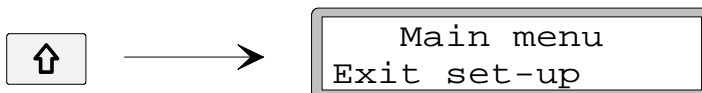

#### 16. Save the changes.

Before 'Quick set-up' is closed, the new parameter values should be saved, i.e. copied to a specific memory in the instrument.

Alternatively the new values can be cancelled, and all parameters will resume the values they had before 'Quick set-up' was started.

Press ENTER to get the sub menu displayed.



(Press **↑** if you do not wish to exit from the set-up mode.)

Press **←** to answer 'Yes', and save the new parameter values.

Press **-** to answer 'No', and cancel the new parameter values.

In both cases 'Quick set-up' is finished and the instrument switches over to Operating mode, displaying a measurement value that depends on the load and the active parameter values.



The scale is now ready for use.

## Dead weight calibration

This is the most accurate calibration type. It requires that known weights to at least two-thirds of the scale capacity are available.

Below, a dead weight calibration in two points is described.

Before editing of these parameters is started, set-up of common parameters, described in point 1. – 8. on pages 7 – 10 should be performed.

### 9. Set the value for calibration point 1.

If the 'Deadweight' alternative was selected at 8. on page 10, next parameter will be 'Value cal. p.1'. This parameter defines the known load on the scale for the lower calibration point.

Press **+** to get the parameter 'Value cal. p.1' displayed.

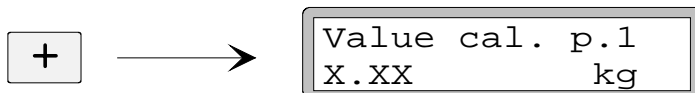

The displayed parameter value is the load on the scale that was set for the lower calibration point in the last calibration, normally zero (= unloaded scale).

Press ENTER.



Actual measurement value for the scale is displayed (as a 'live' weight value) with a cursor and one decimal more than what is set in parameter 'Resolution'. Check the load on the scale (normally unloaded).

Press ENTER again to make editing possible.

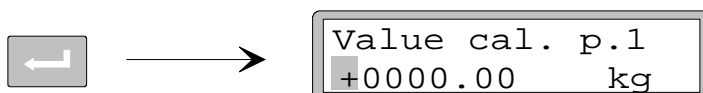

The displayed parameter value is the value for calibration point 1 from the last calibration, with leading sign and a cursor.

The parameter value can be edited, according to point 6. on page 9 (numerical parameter), to correspond to the actual load on the scale, normally zero.

Press ENTER for 2 seconds.

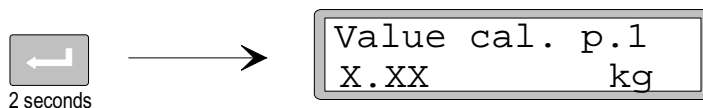

This finishes the editing and the load that is set for the lower calibration point is displayed without cursor.

### 10. Set the value for calibration point 2.

This parameter defines the known load on the scale in the higher calibration point.

Press **+** to get the parameter 'Value cal. p.2' displayed.



The displayed parameter value is the load on the scale that was set for the higher calibration point in the last calibration.

Press ENTER.

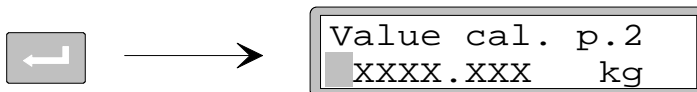

Actual measurement value for the scale is displayed (as a 'live' weight value) with a cursor and one decimal more than what is set in parameter 'Resolution'.

Load the scale with known weights to at least two thirds of the scale capacity.

Press ENTER again to make editing possible.

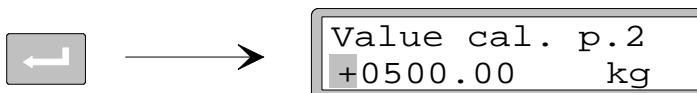

The displayed parameter value is the value for calibration point 2 from the last calibration with leading sign and a cursor.

The parameter value can be edited, according to point 6. on page 9 (numerical parameter), to correspond to the actual load of known weights on the scale.

Press ENTER for 2 seconds.



Editing is finished and the load that is set for the higher calibration point is displayed without cursor.

### 11. Read the transducer signal for calibration point 1 (read only).

By installation later of a replacement instrument, it is useful to know the value of the transducer signals for the two calibration points.

Press **+** to get parameter 'Transd.sign. p.1' displayed.

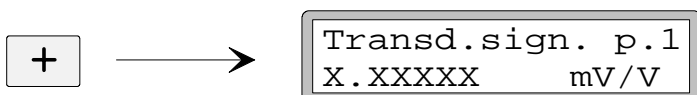

Make a note of the parameter value in the Quick set-up list, appendix 1.

### 12. Read the transducer signal for calibration point 2 (read only).

Press **+** to get parameter 'Transd.sign. p.2' displayed.

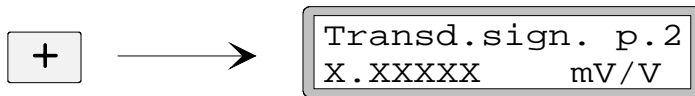

Make a note of the parameter value in the Quick set-up list, appendix 1.

### 13. Set the scale to zero.

This parameter displays the weight value with actual settings (but with one decimal more than what is set in 'Resolution'). Use it to set the weight value to 'zero' for the unloaded scale.

Press **+** to get parameter 'Set zero' displayed, and check that the scale is unloaded.



Press ENTER to set the parameter value to zero.



The value is set to zero with leading sign and a cursor blinking.

Press ENTER for 2 seconds.

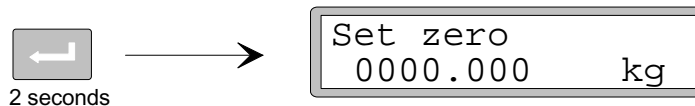

The cursor disappears and the zero setting is accepted.

### 14. Read the zero offset.

By installation later of a replacement instrument, it is useful to know the total zero offset value for the scale.

Press **+** to get parameter 'Zero offset' displayed.

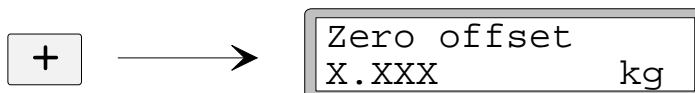

Make a note of the zero offset value in the Quick set-up list, appendix 1.

### 15. Exit 'Quick set-up'.

Press ESCAPE to get to 'Main menu Exit set-up'.

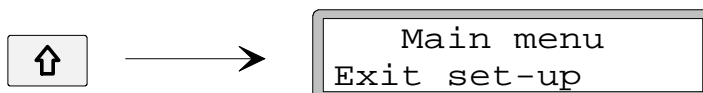

### 16. Save the changes.

Before 'Quick set-up' is closed, the new parameter values should be saved, i.e. copied to a specific memory in the instrument.

Alternatively the new values can be cancelled, and all parameters will resume the values they had before 'Quick set-up' was started.

Press ENTER to get the sub menu displayed.



(Press  if you do not wish to exit from the set-up mode.)

Press  to answer 'Yes', and save the new parameter values.

Press  to answer 'No', and cancel the new parameter values.

In both cases 'Quick set-up' is finished and the instrument switches over to Operating mode, displaying a measurement value that depends on the load and the active parameter values.

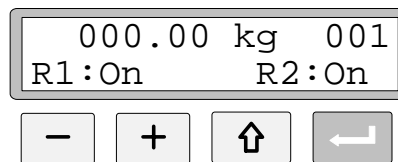

The scale is now ready for use.

# Parameter survey

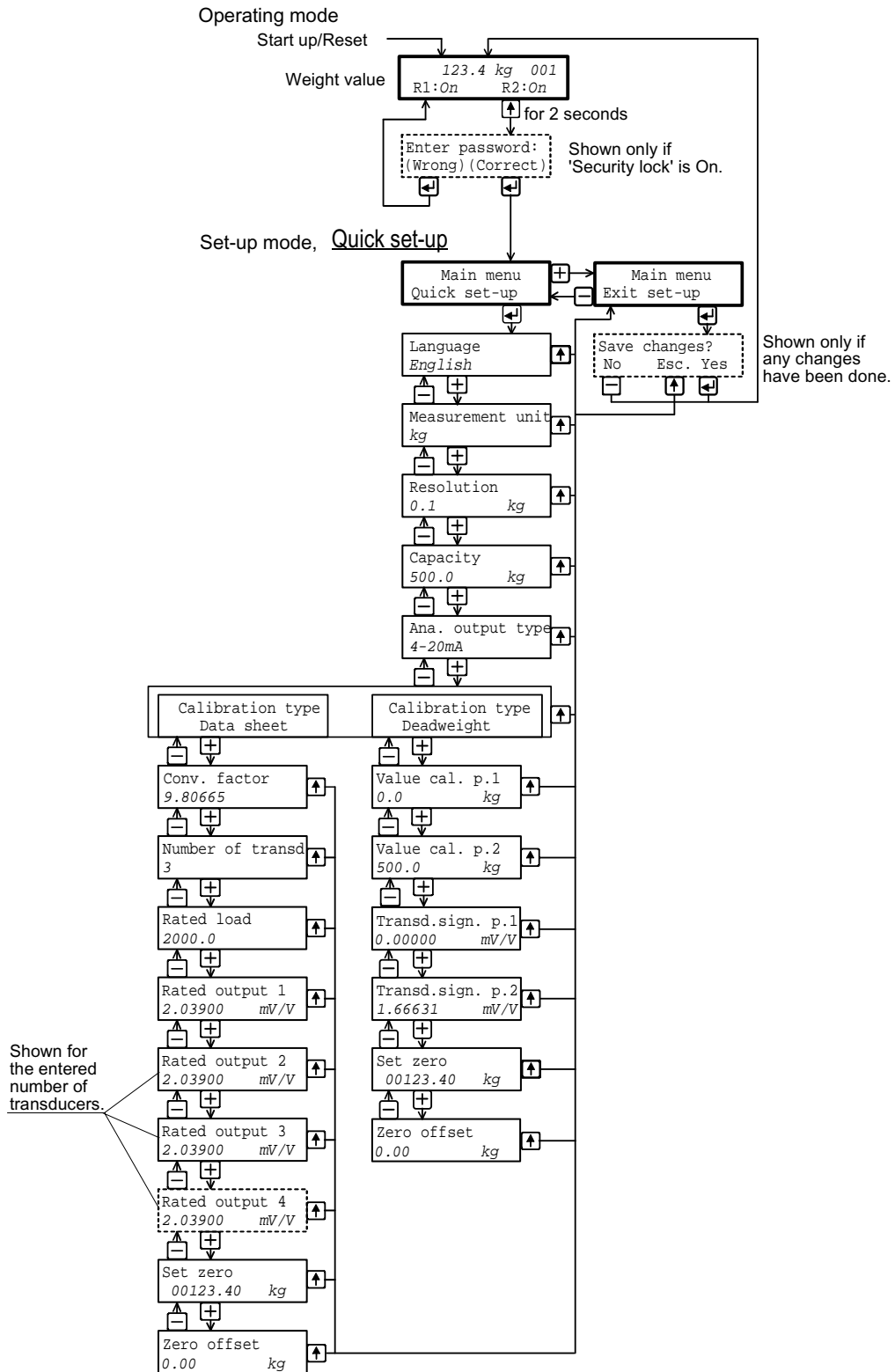

The diagram shows the parameters in 'Quick set-up' and how the function keys are used to view the parameters.

## Quick set-up list for AST 3 ..... Address: .....

Location/Notes: .....

Programme name: ..... Ser. no.: ..... Date: .....

Parameter name	Default value	Set-up value	
Language	English	.....	.....
Measurement unit	kg	.....	.....
Resolution	0.1	.....	.....
Capacity	500.0	.....	.....
Ana. output type	4–20mA	.....	.....
Calibration type	Data sheet	.....	.....
Conv. factor	9.80665	.....	.....
Number of transd	3	.....	.....
Rated load	2000.0	.....	.....
Rated output 1	2.03900	.....	.....
Rated output 2	2.03900	.....	.....
Rated output 3	2.03900	.....	.....
Rated output 4	2.03900	.....	.....
Value cal. p.1	0.0	.....	.....
Value cal. p.2	500.0	.....	.....
Transd.sign. p.1	0.00000	.....	.....
Transd.sign. p.2	1.66631	.....	.....
Zero offset	0.00	.....	.....

*Operating instructions, Quick installation*





*Operating instructions, Quick installation*

Publication 600 243 R9      Ä.O. 950 259  
© Vishay Nobel AB, 03-06  
*Subject to changes without notice.*



Vishay Nobel AB  
Box 423, SE-691 27 Karlskoga, Sweden  
Phone +46 586 63000 · Fax +46 586 63099  
info.se@vishaynobel.com · www.vishaynobel.com